



CAKASA

(NIG) COMPANY LIMITED



THE LEADING
EPICOM
SERVICE PROVIDER
General Profile

...The Nigerian Dream Team of EPICOM Services





WORLD CLASS
**PROJECT
DELIVERY**



TABLE OF CONTENT

1	About Us	Pgs 7-11	
2	Gas Services	Pgs 12-52	
3	Civil & Infrastructure Projects	Pgs 53-65	
4	Construction of other retail outlets & White products storage facility	Pgs 66-90	
5	Some Operate & Maintenance Services	Pgs 91-99	
6	Upstream/Offshore & Installation projects	Pgs 100-107	
7	Equipment & Leasing services	Pgs 108-109	
8	Procurement services	Pgs 110	
9	Human Capacity Development Training /CSR	Pgs 111-113	
10	Project Listings	Pgs 114-118	
11	Statutory Permits/ Job Completion ISO Certifications	Pgs 119-123	
12	Awards	Pgs 124-125	
13	Cakasa Nigerian Content Policy/ HSES & Quality Policy	Pgs 126-128	
14	Strategic Partners/Client	Pgs 129-131	
15	Contact	Pg 132	

ABOUT US

Company Overview

CAKASA (Nigeria) Company Limited was incorporated in 1974 and commenced operations as a trading house in 1979. Through strategic foresight and sound management principles, CAKASA has evolved to become an unrivaled Engineering, Procurement and Construction (EPC) entity; an undisputed leader in Facilities Operation and Maintenance Services; and a one-stop shop for provision of Equipment and Leasing Services. Our world class services are deployed to clientele in the oil & gas (Upstream Midstream and Downstream sub sectors) and infrastructure industries of the Nigerian and West African sub-regional markets.

CAKASA has in place a disciplined and client focused framework built on a flexible and dynamic approach that makes it feasible to create, build and deliver value that meets the diverse and specific needs of each client. At the heart of this framework is a people-oriented paradigm that consciously harnesses, integrates and leverages the collective intellectual capital of our workforce. This has a powerful effect of encouraging and empowering the employees to develop innovative solutions for complex challenges, without compromising quality, health, safety and environment standards.

CAKASA's vast knowledge wellhead built over four decades of EPC capability and expertise promotes collaboration and provides a systematic way to capture, share and reuse the knowledge to provide cost effective, intelligent solutions in a timely manner. Thus, the systematization of our processes and systems was inevitable. **CAKASA** was one of the first indigenous companies to be ISO 9001 certified in the Nigerian Oil & Gas Sector. We are currently at the verge of integrating our management systems (IMS) to include ISO 9001; Quality management system (QMS), ISO 14001; Environmental management system (EMS) and ISO 45001; Occupational health and safety management systems (OSHAS). To get to this point, CAKASA implements the highest standards of corporate governance and specifically submitted itself to third-party checks through its certification by the United States based Trace International

WHO WE ARE

Vision

To be a world class engineering solutions company of choice.

Mission

To passionately provide engineering solutions that exceed customers' expectation.

Core Values

Diversity | Professionalism | Quality + Safety
Integrity | Customer Satisfaction

ABOUT US

50 Years Of Core Competence Development

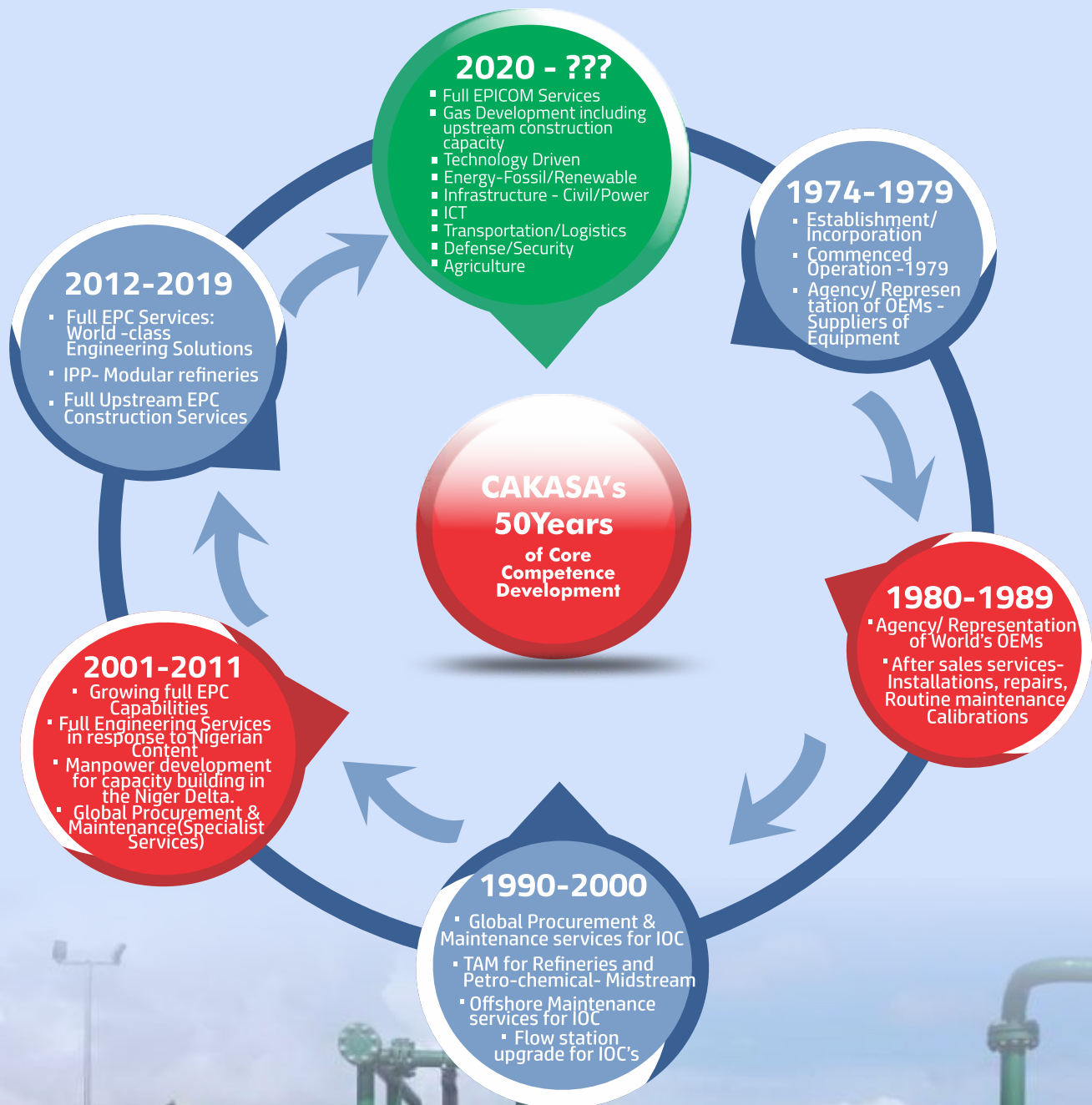

NIGERIAN CONTENT PLAN

CAKASA QUALITY POLICY STATEMENT

We shall continuously deliver Engineering, Procurement, Construction and Post-Installation services to the Oil & Gas, Industrial, Energy and Infrastructure clients, that meets our stakeholders needs and expectations as a demonstration of our total commitment to our customers and continual improvement of our Quality Management System.

NIGERIAN CONTENT PLAN

It is our intention to promote the Nigeria Content initiative of the Federal Government of Nigeria in optimizing the use of Local resources and materials in the execution of our projects.

Cakasa understands the need for sustainable development, and we are committed to the concept and the use of local resources. To this end, we shall continue to employ and train Nigerian citizens in all the disciplines that support the execution of our projects.

We expect the mix of our personnel and those of our partners to Cakasa over the next years as our personnel acquire the experience and skill to perform the work.

HEALTH, SAFETY & ENVIRONMENT

Successfully managing HSE issues is an essential component of our business strategy. Through the observance and encouragement of our HSE policy and program, we assist in protecting the environment and the overall well-being of all of our stake-holders. Specifically, our employees, clients, subcontractors and host communities. Our goal is to minimize impact to the environment and prevent harm to all who could be affected by our operations.

We are committed to reducing waste, emissions and discharges in all areas where we work and by using energy efficiently. We strive to be good citizen in every community in which we operate. Cakasa will maintain awareness of HSE issues, so as to be proactive in providing a value-added service to our client.

Engineering Services

...In collaboration with our subsidiary CESL (www.cakasaengineering.com)

- Economic and Technical Feasibility Studies
- Conceptual Design
- Front End Engineering Design (FEED)
- Detailed Engineering Design (DED)
- Drafting & As Built drawings (3D Modelling inclusive)
- Laser Scanning & Dimensional Control
- Project Management



**MID & DOWN
STREAM**

UPSTREAM

PHOTO GALLERY

- **EQUIPMENT
LEASING-
Constr. Eqipt.**
- **CSR**

- **INFRASTRUCTURE-
CIVIL/POWER**
- **FOOD PROCESSING**

GAS **SERVICES**



ABOUT US

CAKASA GAS UNIT was established in 2006 to provide an integrated value addition gas project services from conception to commissioning and maintenance by leveraging on our highly skilled and qualified engineers and our partnership with world class products and service providers. The individual and collective expertise of our engineers and principals gives us the cutting edge, to provide cost-effective solutions that maximize our clients' assets, improve their competitive position and increase their long-term business success.

CAKASA was one of the first indigenous companies to be ISO 9001 certified in the Nigerian Oil & Gas Sector. We are currently at the verge of integrating our management systems (IMS) to include ISO 9001; Quality management system (QMS), ISO 14001; Environmental management system (EMS) and ISO 45001; Occupational health and safety management systems (OSHAS).

We use a flexible approach for building value to meet the diverse needs of each client.



OUR SERVICES



WORLD CLASS
**PROJECT
DELIVERY**





**QUALITY
&
GOOD SAFETY
MEASURES**



**ENGINEERING
SOLUTIONS
AT ITS BEST**

Fully Erected, Tested, Painted & Ready For LPG Storage



PROFESSIONALISM
& INTEGRITY

Construction Services

LPG Depot Development - On Turnkey Basis Comprising of Ship Berthing Facility/Jetty, LPG Storage Spheres, Truck Loading Bay, Civil Works, Piping, Mechanical, Electrical/ Instrumentation, Fire Fighting Systems and CNG Facility development;

- **Erection & Welding of Spherical Tanks**
- **Supply and Installation of LPG Bullet Tanks**
- **LPG Bottling Plant Facility Development**
- **Construction of Auto CNG & LPG Stations**



CIVIL WORKS - PILING & FOUNDATIONS



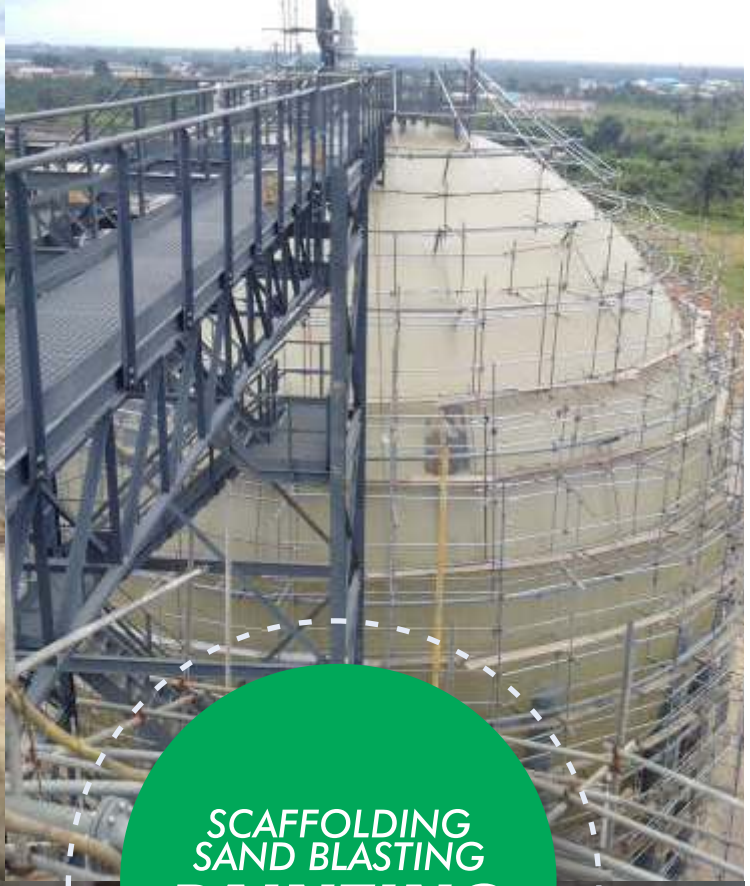

SCAFFOLDING
SAND BLASTING
PAINTING

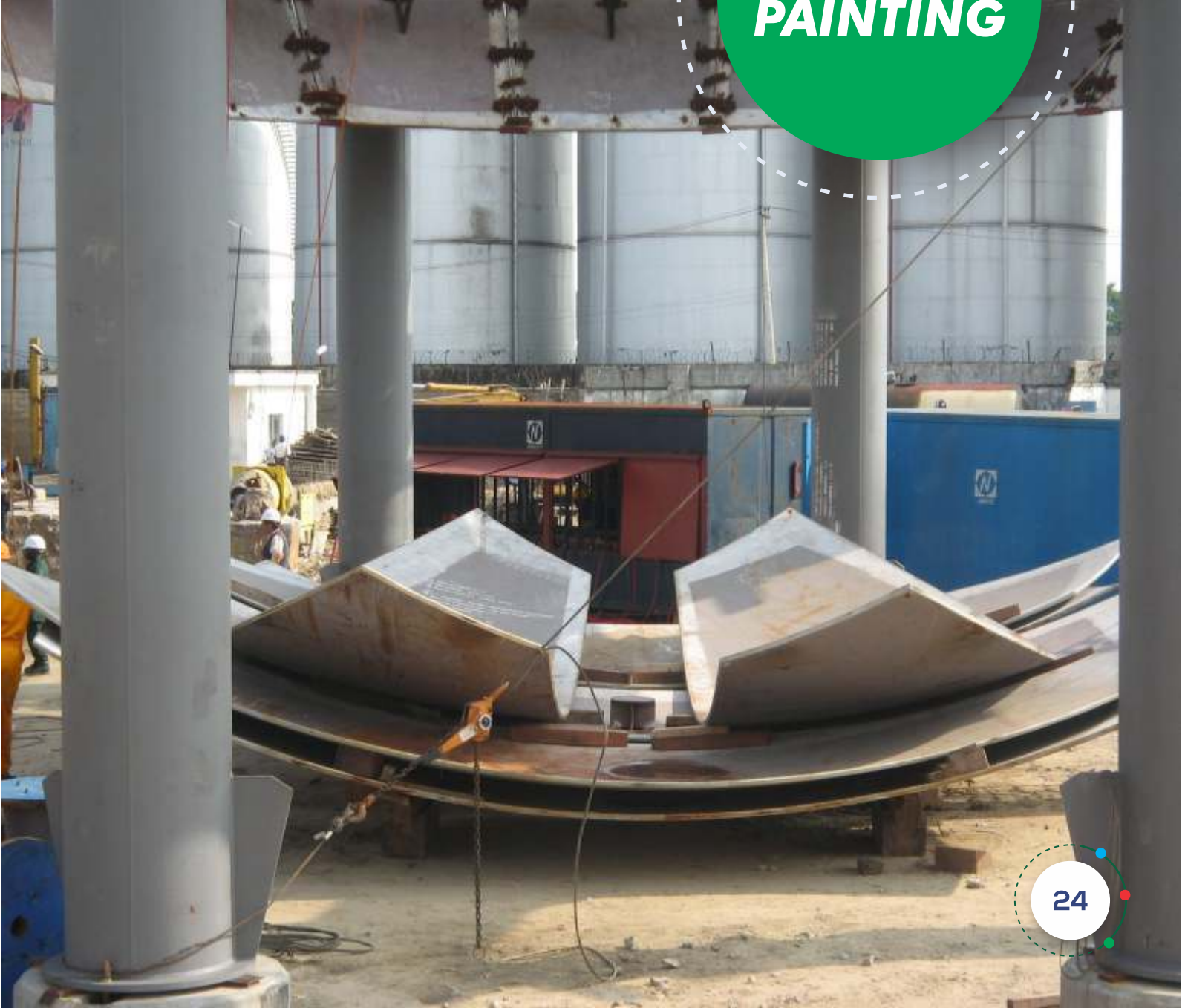

Sphere/Bullet Construction Details



Sphere Construction

Mounded Bullet Construction



**ERECTION
& WELDING
PROCESS**

LIQUID BULK

Description: 1No x 4,000MT, 100% Propane LPG Tank

Location: Port Harcourt

Scope: Construction

Status: 2022(Ongoing)



PROPANE

STOCKGAP FUELS

Description: Expansion of LPG Terminal with 1 No X 4,000MT, 100% Propane tank under live plant condition

Location: Portharcourt

Scope: Construction

Status: Completed (2024)



A.Y.M SHAFI

Description: 2Nos x 2,500MT each of LPG Storage Tank

Location: Warri

Scope: Piling, Foundation, Mechanical construction, Piping & Instrumentation

Status: Completed & Commissioned, 2021



TECHNO OIL

Description: EPC 2Nos x 4,000MT with 2+1 loading bay, Administrative Building, security and technical building which include installation of M & E, Plumbing and safety equipments

Location: Kirikiri - Lagos

Scope: EPC Turnkey Project

Status: Completed & Commissioned, 2020



FALCON PROJECT

Description: EPCI for 15000MT LPG Facility for Falcon Kinetics

Location: Rumuolumeni, Port Harcourt, Rivers State

Scope: EPCI Turnkey Project

Status: On-going (2022-2025)



ONGOING LPG SPHERE TANK CONSTRUCTION (PRESENT STAGE)



SPHERE

DOZZY OIL/KINGSCROWN

Description: 1 No x 5000MT LPG Sphere
Location: Calabar
Scope: Construction
Status: Completed 2019



LPG Bullet Construction in Progress



LPG Bullet Tank Construction for Stockgap in progress





Procurement & Logistics Services

...Product ranges from the following OEMS from Europe, USA, Brazil and Asia

- Bottling Plant Equipment – Makeen Energy (Kosan Crisplant/Siraga)
- Foreign and Local Procurement Services (Global Supply Chain Solution)
- CNG/LPG Dispensing Units - Tatsuno, Japan/India, IMW
- Sphere & Storage Plates Manufacture – Paresa Italy.
- Bullet Tanks - Globegas & OPTECH, India

MAKEEN

ENERGY 

Solutions for the LPG Cylinder filling Industry



makeenergy.com



kosancrisplant.com siraga.com

BOTTLING/ FILLING PLANT

SHAZZAGORO

Description: Upgrade of existing bottling plant at kaduna with state of the art equipment from Kosan Crisplant

Location: Kaduna

Scope: Construction

Status: Completed & Commissioned, 2013



BOTTLING/ FILLING PLANT

DADDO GAS

Description: Construction of LPG Bottling plant with storage capacity of 100MT in Calabar
Location: Calabar
Scope: Construction
Status: Completed & Commissioned, 2012 - 2013





LPG TRUCK
Loading Gantry with
EMCO WHEATON
System





LPG TRUCK
Loading In Progress



Installation, Comm & Mtce Services

We undertake the Installation & Maintenance of the following:

- Marine Loading Arms
- Molsieve/Catalyst Change-out
- LPG Pumps, Compressors, Valves & Weighbridges
- Filling Plant Installation & Maintenance
- Control Room Electronics/ESD Systems
- Fire Detection & Fighting System







AUTO CNG & LPG TECHNOLOGIES

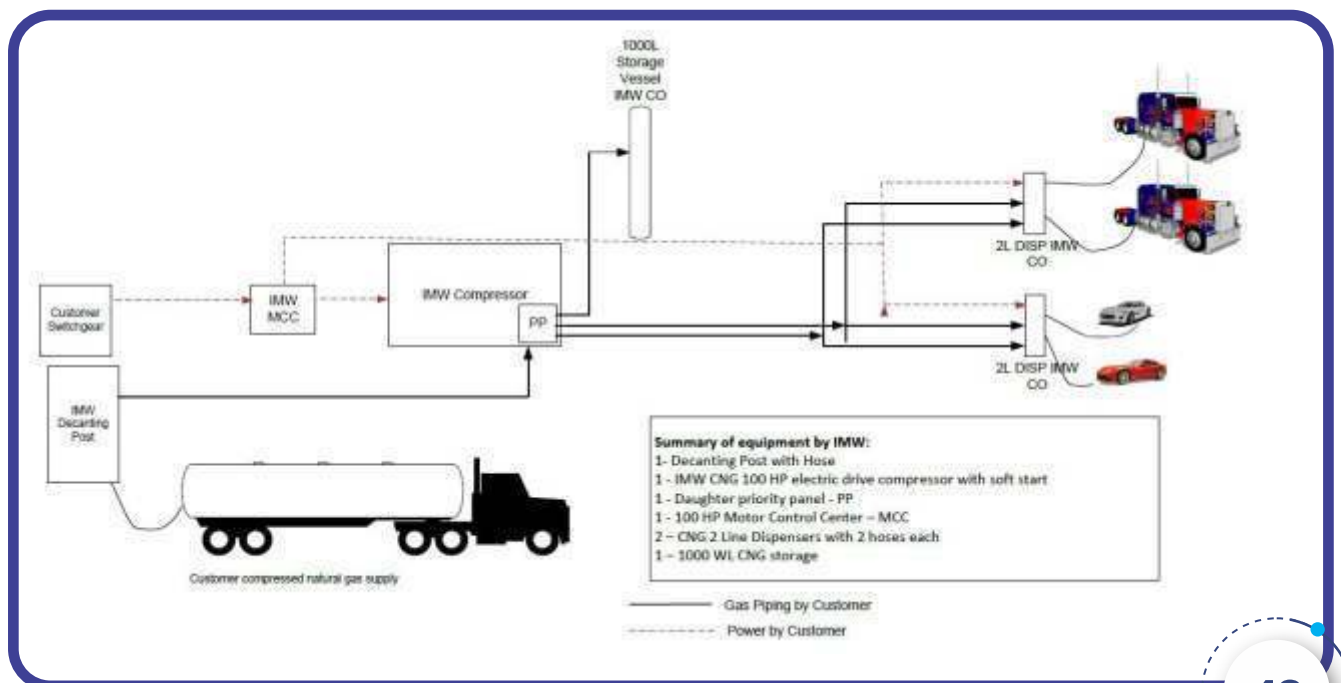

CNG DAUGHTER STATION IN ABUJA LUGBE

Description: Construction of CNG daughter station at Lugbe, Abuja

Location: Lugbe, Abuja

Scope: EPC

Status: Completed 2025



AUTO CNG & LPG TECHNOLOGIES

TATSUNO DISPENSER (WHITE PRODUCT & LPG)/IMW



...Your Dependable Local Partner For Gas Technology

CNG/LPG RETICULATION SYSTEM

RETICULATED PIPE GAS SYSTEM

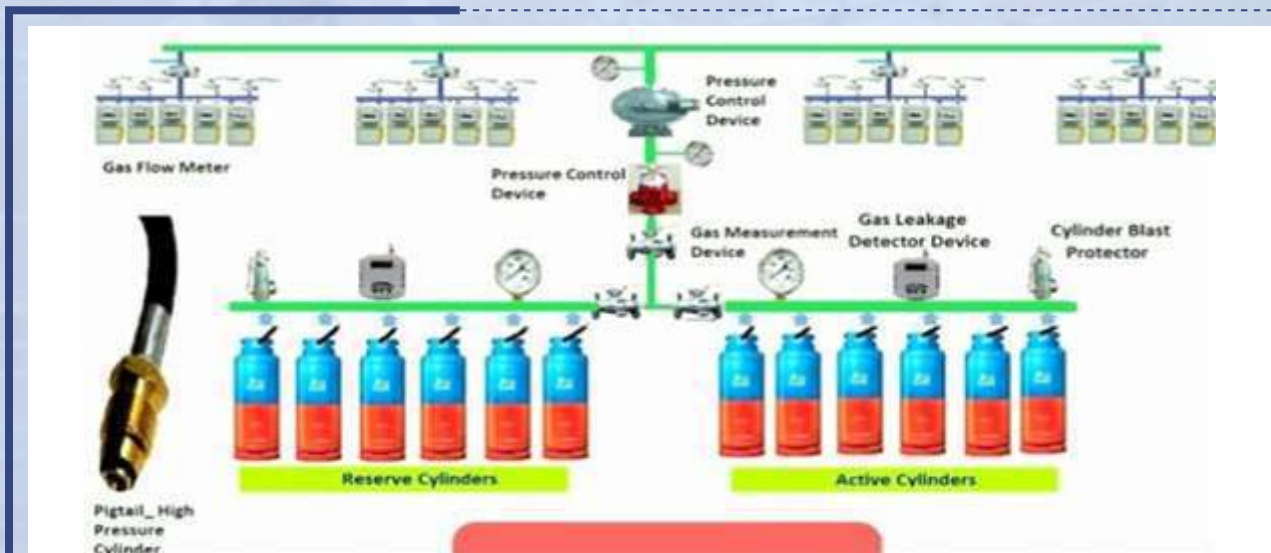
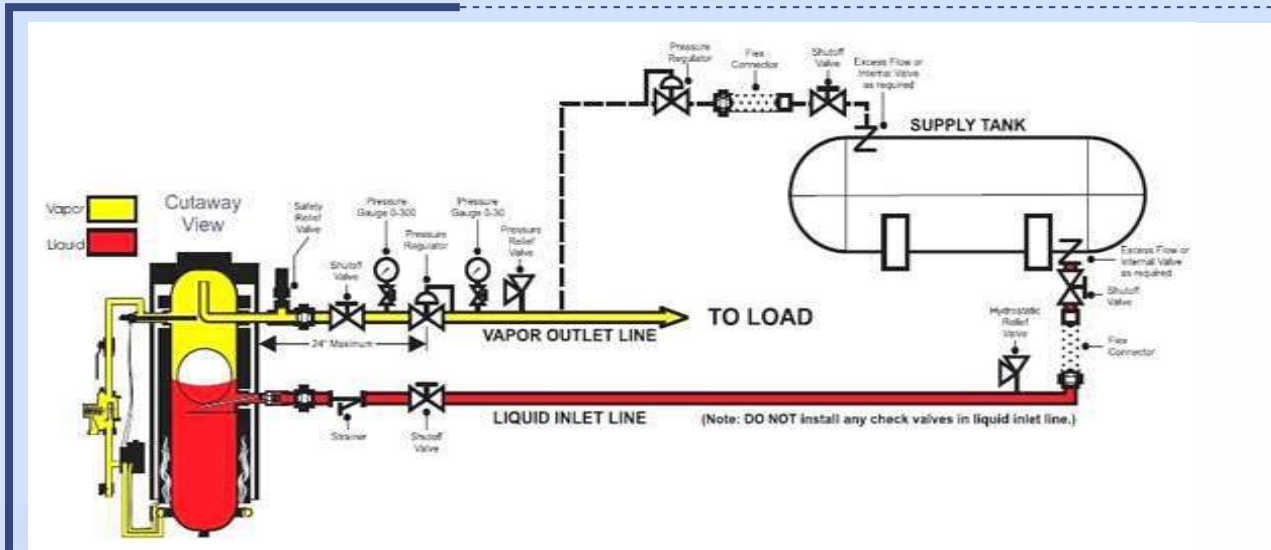

CLIENT: NAF
LOCATION: PORT HARCOURT
SCOPE: EPC OF NAF ESTATES (2024 -2025) ON GOING



CNG/LPG RETICULATION SYSTEM

SMART GAS METER



DIAGRAM GAS METER

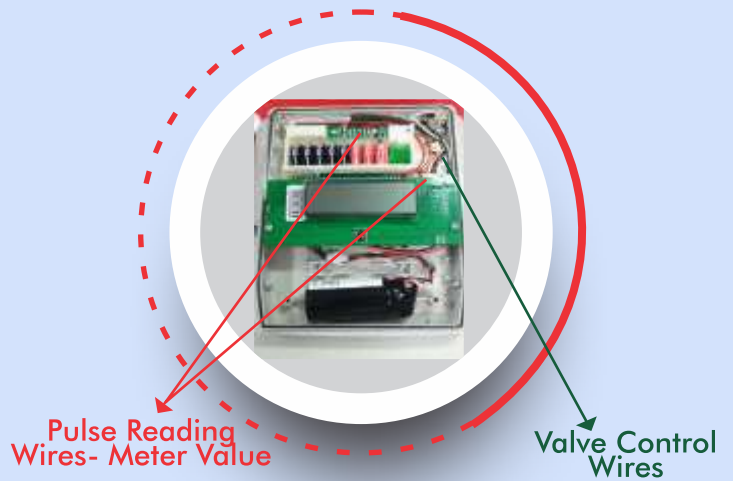

SMART METER ARCHITECTURE

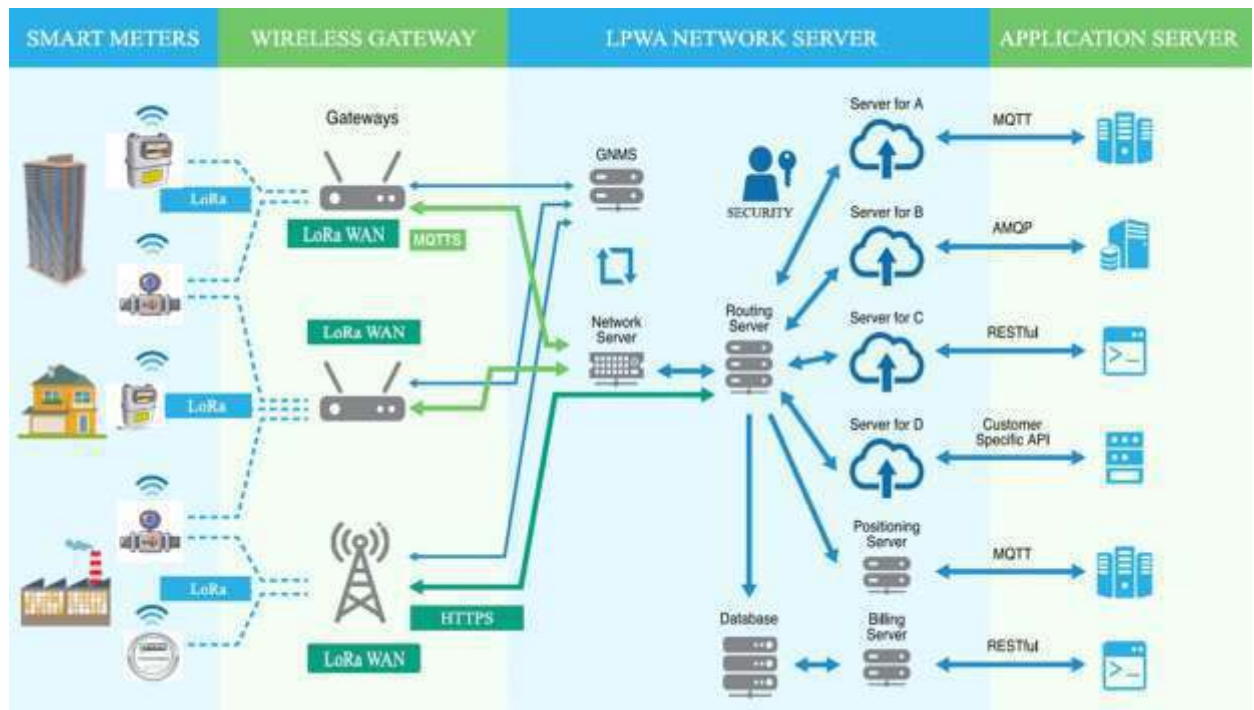

CIVIL & INFRASTRUCTURE PROJECTS



Infrastructure Services (Civil/Power)

This a new Strategic Business Unit to provide services to the Civil & Power Infrastructure sector. We are in partnership with foreign companies and our local Associate company Vibroflotation & Geotechnical Nig. Ltd (VGNL) to provide the following services:

- Transportation: Highways, Bridges, Roads, etc.
- Water Resources :Portable Water Supply Scheme, Boreholes, Dams etc.
- Buildings: High-rise, office complex, high/low cost Housing estates, shopping malls, etc.
- Electricity: Rural and Urban Electrification Projects. Transmission & Distribution. Metering System. Renewable Energy-Solar Energy
- Ground / Soil Improvement:
 - a) By Vibroflotation Methods – VibroCompaction, Stone Columns, Offshore Stone Columns and Vibro Concrete Columns.
 - b) By Piling Method – Drilled by Continuous Flight Auger (CFA) System
- Geotechnical Survey
- Shoreline Protection by Sheet Piling etc.
- Dredging Services
- Jetty and Dolphine Design and Constructions.



SAFETY CENTRE INTERNATIONAL

Client: Safety centre International

Project: Construction of Safety Training Centre

Location: Omogwa, Port-Harcourt

Scope: Structural Engineering, Procurement, Construction & Installation of Mech, Elect, Plumbing and Safety Equipment.



ST. LEO CATHOLIC CHURCH

Client: St LEO Catholic Church

Location: Opebi, Ikeja.

Scope of Work: Construction of a 3storey civic centre

Status: Completed 2009



NDPR TRAILER PARK

Client: NDPR Trailer Park

Location: Ogbele, River State

Scope: Construction of 133 X 63 Sqm. Trailer Park (Pavement & Accommodation) for the Ogbele Refinery

Status: Completed 2023



PIP I & II

Client: PIP I & II

Location: Calabar, Cross River

Scope: EPC Contract of Access Road, Pavement, Drainage, Walkways etc.

Status: Completed 2013



CIVIL/INFRASTRUCTURE

PROJECT

WAPIC

Client: WAPIC

Location: Ikoyi, Lagos

Scope: EPC & Furnishing of 4-Storey Building as Headquarters of WAPIC



PHCN

Client: PHCN

Location: Benin, Edo State

Scope: EPC of Regional Control Building (With Helipad)

Status: Completed 2014



AMEC ENGR. LTD

Client: AMEC ENGR. LTD

Location: Orile – Iganmu, Lagos

Scope: Supply & Construction of pavement, Concrete works, Kerbs, Drainage etc covering 8 Hectares for Oil Tankers Parking.

Status: Completed 2007



PUMA ENERGY

Description: 18,000MT Bitumen Depot with 30,000 DWT jetty facility

Location: Apapa, Lagos State

Scope: EPC on turnkey basis for tank farm, jetty/shoreline, civil structures, piping & fire fighting system

Status: Completed 2018



NORTHWEST

Description: Construction of 20,000DWT Jetty and 250mtrs shoreline

Location: Calabar Free Trade Zone

Scope: EPC of white pet. product jetty/shoreline, civil structures, fire fighting towers/systems & landscaping

Status: Completed 2013



KRPC

Description: Refinery Cooling Tower Rehabilitation Project

Location: Kaduna

Scope: EPC of 10cells x 1975M3/Hr High Efficiency FRP Cooling Towers,
Chemical Dosing Facility & Filtration System

Status: Completed 2000-2001



WARTSILA

Description: 18MW Power Station

Location: Unicem, Calabar

Scope: Civil Works, Piping and Equipment Installation

Status: Completed 2014



INFRASTRUCTURE ATIL

ATIL

Client: ATIL
Location: Port Harcourt Rivers State
Scope: Power Plant
Status: On-going



CONSTRUCTION OF OTHER RETAIL OUTLETS & WHITE PRODUCT STORAGE FACILITY

FOUNDATIONS & KERBS, BUILDING, PAVEMENT, DRAINAGE, EQUIPMENT



DOWNSTREAM RETAIL OUTLET

NORTHWEST PETROLEUM

Client: Northwest Petroleum

Location: Maryland, Lagos

Scope: Major facilities include administrative building, generator house, 20nozzle PMS, 4 nozzle AGO, 2nozzle DPK, e.t.c

Status: Completed 2023



DOWNSTREAM RETAIL OUTLET

NORTHWEST PETROLEUM

Client: Northwest Petroleum

Location: Maryland, Lagos

Scope: Northwest Petroleum Mary Land Mega filling Station Construction Works

Status: Completed 2023



NORTHWEST PETROLEUM

Client: NORTHWEST

Location: Abule Egba, Lagos IV

Scope: Major facilities include a 8nos PMS nozzles, 2nos AGO nozzles, 2nos DPK nozzles, a 9X25.3m station building

Status: Completed 2020



NORTHWEST PETROLEUM

Client: NORTHWEST

Location: Gbagada, Lagos III

Scope: Major facilities include a 24nos nozzles PMS, 4nos nozzles AGO, 2nos nozzles DPK, administrative building, drivers lounge, water treatment plant, dedicated transformer , tanker's park. etc

Status: Completed 2020



NORTHWEST PETROLEUM

Client: NORTHWEST

Location: Asaba II

Scope: Major facilities include a 20nos nozzles PMS, 4nos nozzles AGO, 2nos nozzles DPK, a 15X30m station building, drivers lounge, water treatment plant, dedicated transformer , tanker's park .etc.

Status: Completed 2019



NORTHWEST PETROLEUM

Client: NORTHWEST

Location: Ajah, Lagos I

Scope: Major facilities include a 14nos PMS nozzles, 4nos AGO nozzles, 2nos DPK nozzles, a 9X15m station building, water treatment plant, dedicated transformer etc.

Status: Completed 2017



PARESA/SAIPEM/DANGOTE

Description: Development of Fertilizer Plant

Location: Lekki Free Trade Zone

Scope: Construction of 1No x 31,982m³ Ammonia Cryogenic Tank in Collaboration with PARESA

Status: Completed 2019



NORTHWEST

Description: Base Oil Blending tank depot construction

Location: Ijegun, Lagos

Scope: Construction of Storage Tanks

Status: Completed 2023



TOTAL NIG. PLC.

Description: JET A1 Aviation Depot

Location: Abuja Airport, FCT

Scope: Procurement, Fabrication, Construction of 2Nos Storage Tanks, Loading Gantry, Product & Fire Fighting System

Status: Completed 2005



DOWNSTREAM BITUMEN DEPOT

PUMA ENERGY

Description: 18,000MT Bitumen Depot with 30,000 DWT jetty facility

Location: Apapa, Lagos State

Scope: EPC on turnkey basis for tank farm, jetty/shoreline, civil structures, piping & fire fighting system

Status: Completed 2018



NDPR

Description: Construction of 14Nos crude & reined product tank farm of 11,000bbls/day modular refinery

Location: Ogbele, Rivers state

Project: Refinery expansion

Scope: Tanks, product pipes, Civil foundation for tanks & Equipment, Loading Gantry, E&I Installations

Status: Completed 2017-2019



IHS KADUNA

Location: Kaduna State.

Scope: Tank Farm Construction for IHS Kaduna (Scope includes access road, pavement, drainage, administrative building, warehouse, security post, MCC building, driver's lounge, general toilet, generator house, bundwall e.t.c

Status: Completed 2023



DOWNSTREAM

WHITE PRODUCTS & BITUMEN

WABECO

Location: Calabar, Cross River

Scope: EPC Contract for the Construction of 110,000MT Storage Tank Farm complete with bundwall, administrative building, workshop, control room, security post etc.)

Status: Completed 2012 - 2015



DOWNSTREAM

TANK FARM/DEPOT CONSTRUCTION

KTL

Location: Calabar, Cross River

Scope: EPC Contract for Complete Tank Farm Construction (Scope includes access road, pavement, drainage, administrative building, gate house etc.)

Status: Completed 2015



NORTHWEST

Client: NORTHWEST DEPOT I

Location: Calabar, Cross River

Scope: EPC of Tankfarm Facility construction (Scope includes, pavement, gate house, administrative building etc.)

Status: Completed 2007



DOWNSTREAM

TANK FARM/DEPOT CONSTRUCTION

BPS

Client: BPS

Location: Cotonou, Benin Republic

Scope: Construction of 40ML White product Storage Tank Farm, Complete with 6Bay Loading Facility (Scope includes pavement, access road, drainage, administrative building, gate house etc.)

Status: Completed 2010



UPSTREAM TANK REHAB



SAPETRO

Description: Crude Oil Tank Refurbishment & Bunded Area Rehabilitation

Location: Seme, Cotonuo

Scope: EPC for Crude Oil Tank Refurbishment, 2 Nos. X 50,000 MT
Including Civil Work and Bund Wall

Year: 2013



PILLAR OIL

Description: Crude Oil Tank Construction

Location: Kwale

Scope: EPC of 2Nos. x 20,000bbls each Crude Oil storage tank complete with piping and fire fighting system including civil works Including Civil Work and Bund Wall.

Year: 2011-2012



MIDSTREAM

FLOWSTATION UPGRADE

ATIL

Client: ATIL

Location: Port Harcourt Rivers State

Scope: Contract for Engineering, Procurement, Construction, Installation and Commissioning of 750,000 barrels onshore terminal facility

Status: On-going



**ROM OIL**

Description: Construction of 15Nos Crude & Refined Palm Oil Storage Tanks with associated piping systems

Location: Ibadan

Scope: Foundation, Mechanical, Piping & Fire Fighting Systems

Status: Completed 2013

DOWNSTREAM

PIPELINE CONSTRUCTION

ARL

Client: ARL

Location: CALABAR CROSS RIVER STATE

Scope: Design and construction of 4nos pipeline (BITUMEN,PMS,AGO,DPK)
from ecomarine jetty to portside industrial park

Status: Completed 2016



Maintenance Services

As far back as 1979, Maintenance and Products services arm of the company commenced as agent / distributor of oil & Gas equipment. We have sustained and successfully developed the Nigerian market for our world class manufacturers in the last 4+ decades. As a result of this, we have been part of the transformation process of these companies.

Our early entrance and progress in technology expertise enabled us prepare for the challenges of the Nigerian content ahead of its promulgation. We started by training a dedicated team to provide after sales services for all equipment sold in Nigeria. This has provided opportunity for Technology transfer and the need to develop a highly technical team to cope with the challenges of providing medium scale and global maintenance services. We have a number of well-maintained equipment and facilities (Upstream-Offshore/Onshore, Marginal Fields, Midstream-NLNG/Refineries & Petrochemicals, Downstream-Depots & Retail Stations) within Nigeria. Our workshop facilities in Port Harcourt is fully equipped to provide onshore workshop/machining services. The Port Harcourt facilities occupy 10,000sqm space.

Specifically, our expertise include Flow Measurement Systems & Solutions, Instrument Calibration Services, Pressure Safety Valve Servicing & Calibration, Flow Control Valve Maintenance & Calibration, Valve Actuator / Motor Operated Valves Servicing & Maintenance, Marine Loading Arms & Control Systems Installation & Maintenance, Brownfield Modification & Facilities Upgrade, Catalyst Handling Services, Reactor Vessels Maintenance & Certification, Reboiler & Heat Exchanger Maintenance and Leased Automatic Custody Transfer(LACT) Unit Operations & Maintenance Services.

Inline with CAKASA Global Plan (which was launched in 2020 following the Covid-19 Pandemic & Subsequent Business Survival Strategy) and in response to the growing demand (of specialised/focused service) of our esteemed customers, our operations and maintenance arm was spin-off in July 2021 to form a new company known as CAKASA MAINTENANCE SERVICES LIMITED (CMSL).

Please visit CMSL website (www.cakasamaintenance.com) for their facilities and full range of services.



SOME OPERATE AND MAINTENANCE EXPERIENCE

S/n	Client	Contract	Year
1	TechnoGas (LPG Facility in Kirikir Lagos)	Maintenance of the Gas facility in Kirikir Lagos	2021-2025
		LPG Terminal Retention Maintenance	2020-2021
2	Rain oil (LPG Facility in Ijegun)	Servicing of loading arms , Actuators and ATG Equipments	2025
3	Aradel Energy Limited (Refinery and Olo Field in Portharcourt)	General Mechanical Works Call-Off Contract for the Refinery /Olo Field	2025- 2026
		Framework Catalyst Changeout contract	2025-2030
4	NLNG	Build a condensate skid, install and maintain all other skids at NLNG Yard	2025-2028
		Framework maintenance for operate and maintain Valves in Shallow Waters	2024-2026
5	SEPLAT		
6	PHRC Portharcourt	Repair of 12nos Product Tanks	2023-2025
7	AYM Shafa (Depot in Warri)	Repair of IFR in 1no. PMS tank	2025
8	AYM Shafa (LPG Facility in Warri)	Maintenance of pump	2024
9	Northwest Mega Station Maryland Lagos	Maintenance of Drains	2024
10	AYM Shafa (White Product Depot Warri)	Repair of the differential product tank foundation	2023
11	Rosa Mystical Energy (Depot in Calabar)	Terminal Maintenance contract eg ,leaking underground pipe repairs, Sealing of payment joints , repair of stone patched area etc	2023
12	Pillar Oil	Repair of crude tank roof plate	2023
13	Aradel Energy Limited (Field in Portharcourt)	Rehabilitation of well lex drilling location	2023
14	Northwest Mega Station Gbagada	Maintenance works eg Sandfilling and grouting of void , extension of generator house ,replace interlocking Stones etc	2022
15	Navgas (LPG Facility in Apapa Lagos)	1)Servicing of valves , Actuators and Solenoids (2) Servicing of Load arms and Dry Break Couplers (3) Installation of Propane unloading compressor	2021-2022
16	Total (White product depot in Marine beach Apapa)	Servicing of loading arms and Deadman valves including perolo grounding devices	2021
17	EROTON	Design a Metering skid , install and maintain for Cawthron channel 1	2018 -2021
		Design a Metering skid , install and maintain for Cawthron channel 2	2018 -2021
		Design a Metering skid , install and maintain for Krakrama	2018 -2021
		Design a Metering skid , install and maintain for Alakiri	2018 -2021
18	Samon Petroleum	Repair of IFR of 2nos PMS Tanks	2021
19	Rain oil (LPG and White product Facility in Ijegun)	Repair of ATK pipeline	2021
20	Northwest Depot Calabar	Repair of 1no fire fighting water pump	2021
21	Dangote Refinery	Repair of damaged pump	2021
22	Rain oil (LPG and White product Facility in Ijegun)	Repair of pipe supports and failed pavement including cast of ramp at the pump house and relaying of interlocking stones	2021
23	Northwest oil and Gas (Mega station 1 calabar)	Repair of failed Pavement	2020
24	Heritage oil at OML 30	Well head platform Repairs services	2018
25	NLNG Bonny	Remove, overhaul/Repairs and Reinstallation of NLNG Condensate of FMC Marine loading arm of jetty 11 revamp	2016
26	Kaduna Refinery	unloading and reducing of molesive including Repairs and Calibration of PSVs	2016
27	Northwest jetty calabar	Maintenance works eg Repair of fence and retaining wall, damaged drains, slab in the pump house , barge	2016
28	Navgas (LPG Facility in Apapa Lagos)	LPG tank cleaning services using specialized breathing Apparatus	2016
29	NLNG Bonny	5years call-off contract for molsieve changeout	2008-2013
30	Chevron Esravos	Gas Plant-molsive Change Out	2014
31	NPDC Benin	PSV Certification, meter proving and servicing	2006-2014
32	Northwest Depot Calabar	Maintenance of Depot 1	2011
33	Northwest Depot Calabar	Repair of IFR of 2nos PMS Tanks	2012
34	Northwest Depot Calabar	Repair of the roof of a product tank and instalation of coverfloat	2007

TECHNO GAS

Client: TECHNO GAS

Location: Warri, Delta State

Scope: Washing of Tank



AYM SHAF A

Client: AYM SHAF A
Location: Warri Delta State
Scope: Repair Of Even Settlement Product Tank
Status: Completed 2023



MIDSTREAM

TANK REPAIR & CONSTRUCTION

PHRC

Client: PHRC
Location: Port Harcourt Rivers State
Scope: Repair Of 12nos Product Tanks
Status: On-going(To be Completed 2025)



NORTHWEST

Client: NORTHWEST

Location: Calabar Cross River State

Scope: Product Tank Roof Repairs including installation of cover float

Status: Completed 2007



MIDSTREAM

PIPELINE CONSTRUCTION

DOZZY

Client: DOZZY
Location: Calabar, Cross Rivers State
Scope: LPG Facility Cargo pipeline from Dozzy jetty to the facility
Status: Completed 2015



MIDSTREAM

PIPELINE MODIFICATION

DOZZY

Client: DOZZY
Location: CFTZ Cross River, Calabar
Scope: Modification of Northwest Cargo Pipeline
Status: Completed 2008



UPSTREAM/OFFSHORE & INSTALLATION PROJECTS

UPSTREAM PROJECT

NDPR (ARADEL)

Client: NDPR (ARADEL)
Location: River State
Scope: Rehabilitation of well 1ex drilling location
Status: Completed 2023



ATIL

Client: ATIL

Location: Port Harcourt Rivers State

Scope: Onshore pipeline, gas line, crude line and water line

Status: On-going(To be completed 2025)



UPSTREAM PROJECT

OML

Client: OML 30
Location: Delta State
Scope: Well Head Platform Repair Services
Status: Completed 2018



UPSTREAM PROJECT

EROTON

Client: EROTON
Location: Cawthorne Channel 2,3 Krakrama And Alakiri Flow Station
Scope: Lack Unit Installation, Commissioning And Pipeline Modification
Status: Completed 2018



NAOC

Description: Ogbainbiri Flowstation Upgrade

Location: Ogbainbiri, River State

Scope: EPC for the upgrade of Ogbainbiri flowstations for 13,000bbls/day to 35,000bbls/day complete with associated arrival manifold, metering system, flare-stack, pumps, piping system & staff accommodation

Year: Completed 2004



NAOC, EXXON MOBIL, CHEVRON, NLNG, KRPC

Description: Catalyst/Molsieve, changeout services

Location: Offshore/Onshore

Scope: Supply of New Catalyst/Molsieve, changeout of spent one using Technivac UK state-of-the-art equipment

Status: Successful Campaign from 1998 till date



EXXON MOBIL & NLNG

Description: Marine Loading Arm Services

Location: Bonny BRT & Bonny FIMA

Scope: Supply, Installation and Maintenance of TechnipFMC Marine Loading Arm & Control Systems

Status: 2015 - 2019

SPDC, EXXONMOBIL, CHEVRON, TEXACO, NAOC, POOC

Clients: SPDC, ExxonMobil, ChevronTexaco, NAOC, POOC, Downstream Markets
Locations: Offshore Platforms, Swamp & Land Stations, Terminals at Bonny, Forcados, and Brass; etc
Scope: Revamp, Maintenance and calibration services; Meters, Prover Loops, sampling Systems, Control Systems, electrical Systems etc



Equipment & Leasing Services

Equipment & Leasing Services Unit was established 2017 to cater for Cakasa equipment. Repairs/maintenance and leasing out Equipment to external clients. This unit has been part of Cakasa success stories in project timely delivery to meet customers' demand and satisfaction. We service our in-house construction unit, procurement unit, gas services unit and external clients.

Our services include but not limited to:

- Supply of certified equipment to construction services unit to carry out construction work for prompt project delivery.
- Make trucks available to procurement services to transport construction materials to project location.
- Generate and supply all ELS requirement to Business Development Unit during bidding.
- Source and assist client for equipment required for smooth operations at project site.
- Equipment and Fleet leasing to external client.
- Carry out Repairs (Maintenance & Servicing) on CNC equipment & external client on request.

CONCRETE BATCHING PLANT





110ton Crawler Crane



75ton Mobile Crane

Procurement Services

CAKASA maintains a strong relationship with reputable overseas Original Equipment Manufacturers (OEMs) whose products are used in the Oil and Gas and Process industries. Through our strong partnerships and alliances with them we supply heavy duty Construction and Rotating Equipment to Upstream, Midstream and Downstream sub sectors as well as Infrastructure Industries.

Our OEMs Partners from USA, Latin America, Canada, UK, Europe, Asia, Middle East, South Africa include but not limited to:

- ◆ TECHNIPFMC: Measurement solutions(Liquid,gas & Integrated systems), Marine Loading Systems.
- ◆ ITT-GOULDS: Centrifugal (Multi-stage, single stage, submersible etc), API & ANSI Pumps
- ◆ ROTORK CONTROLS: Electric actuators (IQ, IQT...) Fluid powered, Valve Gearboxes & Instrument Control (www.Rotork.com)
- ◆ IMW: Manufacturer of Automotive, CNG & LPG dual fuel conversion kits/System
- ◆ Tecknowgas: LPG, CNG & LNG Consultant
- ◆ Gardner Denver/Emco-Wheaton - LPG truck loading Arms, folding staircase and grinding device.
- ◆ Makeen Energy - LPG Depot & Bottling plant equipment, supply and maintenance
- ◆ Globe Gas: LPG Bullet Tanks & Equipment Manufacturer (www.globegas.com)
- ◆ Sarl Sara/ MB Fluid/ ISI (France) - Complete Fire fighting systems
- ◆ Paressa, S.p.A. : LPG spherical tanks and pressure vessels fabrication.
- ◆ Tatsuno India Petroleum Limited- Dispensing Pumps and Accessories



Human Capacity Development & Training

On 30 September 2021, CAKASA established a training centre (known as CNC Training School) that utilises blended learning to bridge the gap between theory and practice for the workforce. It is the platform for incubating and birthing ideas, molding the minds and attitudes of the staff to foster an ethical work environment, and building and entrenching employee capacity, in terms of skills and competencies.

Headquartered in Lagos, the Training School serves as the first contact between the company and every new employee, supports our Strategic Anchors, and uses the Pyramidic Approach to build and hone the skills of our team members and thereby equip them to compare preeminently with the best anywhere. Today, the Training School has not only become foremost manpower development centre but the cooking pot of future leaders of the Company

We undertake specialist training at manufacturers' plants in Europe, America, UK and Asia

We also undertake on-site welding & fabrication training at our various project site and fabrication at Lagos



Corporate Social Responsibility (CSR)

CAKASA EBENEZER FOUNDATION (CEF) incorporated in 2014 is the Corporate Social Responsibility (CSR) arm of **CAKASA NIGERIA COMPANY LIMITED (CNC)** dedicated to serve the cause of humanity through collective efforts and partnership whilst bringing joy and hope to many.

CEF has aided public primary and secondary schools in Lagos and Port Harcourt respectively through:

- Infrastructural development – provision of desks and chairs, library upgrade, establishment and running of CEF book club for Government Girls Secondary School, Oromenike Port Harcourt
- Educational scholarships - provision of a two-tier scholarship (Secondary & Tertiary) for 10 girls in Education District 1, Alimosho Local Government in Lagos,
- Educational materials - provision of notebooks, school uniforms & school bags for pupils in New City and Palm Avenue primary schools in Mushin, Lagos
- Provision of psychosocial support for pupils of New City and Palm Avenue Primary Schools Mushin Lagos.
- Learning beyond the classroom initiative
 - collaborated with other partners to empower over 1.000 girls in the annual summer leadership camp for Education District 1, Education District 3 and Education District 4 in Lagos State.
 - Collaborated with the Federal Road Safety Corps (FRSC) in the inauguration and running of road safety clubs in New City, Palm Avenue and Oduduwa Primary Schools in Mushin Lagos state.
 - Collaborated with private individuals to provide school meals for pupils of New City and Palm Avenue Primary schools.

CEF has aided various households in the provision of educational support, health support and economic empowerment in various areas of Lagos and Rivers state respectively.



Corporate Social Responsibility - (CEF) Activities



Kit a child back to School Project



Education & Community Development



Project Library



Women Empowerment

PROJECT LISTING

...our 50years of EPICOM service experiences:

CLIENT / LOCATION	PROJECT DESCRIPTION	SCOPE	YEAR
TECHNO GAS FACILITY	Maintenance Contracts	EPC	On-going (2026)
TECHNIMONT/PHRC, P/H	Rehabilitation of 12nos Tanks in Conjunction with PARESA for PHRC, Port Harcourt	C	Ongoing (2025)
FALCON CORPORATION	Basic Engineering for 3Nos X 5,000MT each LPG Sphere & Detail Engineering Design.	E	On-going (2025)
ATIL	Contract for Engineering, Procurement, Construction, Installation and Commissioning of 750,000 barrels onshore terminal facility	EPC	Ongoing (2025)
	Contract for Engineering, Procurement, Construction, Installation and Commissioning of flow station gas power plant	EPC	
	Contract for Engineering, Procurement, Construction, Installation and Commissioning of Onshore pipeline piping connection system	EPC	
ARADEL HOLDINGS	Construction of completion of 5Nos storage tanks + tank access platform	CP	Ongoing (2025)
AYM SHAFa	Construction of CNG daughter station at Lugbe Abuja	EPC	Completed (2025)
MASTERS ENERGY	Construction of LPG & Propane spheres for Masters Energy at Port Harcourt	C	Ongoing (2025)
TRIANSEL GAS LIMITED	Construction of 2Nos X 5,000M3 LPG Spheres for Triansel Gas Limited at Koko Delta State	C	Ongoing (2025)
ARADEL HOLDINGS	Construction of 10,000MT barrels slop tanks, foundation, erection and lagging etc	EPC	Ongoing (2025)
ALL GRACE ENERGY	Construction of (2) Crude tanks and (1) water tank	EPC	Ongoing (2025)
STOCKGAP ABUJA	Construction and installation of 3nos x 220m3 LPG mounded bullet tanks	C	Completed 2024
STOCKGAP IKENE	Construction and installation of 3nos x 930m3 LPG mounded bullet tanks	C	Completed 2024
STOCKGAP PORTHARCOURT	Construction and installation of 2nos x 630m3 LPG mounded bullet tanks	C	Completed 2024
STOCKGAP FUELS, PH Phase III	Construction of additional 1No. X 4,000MT, 100% Propane Tank under live plant condition	C	Completed (2024)
NORTH WEST PETROLEUM, LAGOS	Base oil blending tank depot construction at Ijegun - Lagos	C	Completed (2023)
LAMBDA GAS DYNAMICS LTD	Otakikpo CPF Loading Gantry System Project	EPCIC	Completed (2023)
I.N.T. TOWERS, KADUNA	Tank Farm for I.H.S Kaduna	EPC	Completed (2023)
NORTHWEST PETROLEUM MEGA STATION, MARYLAND, LAGOS	EPC of Mega filling station (Scope include Administrative building, generator house, 16PMS nozzle, 4 AGO nozzles, 2 DPK nozzles, electrical, underground tank fabrication etc)	EPC	Completed (2023)
I.N.T TOWERS TANK FARM, KADUNA	Tank Farm Construction for IHS Kaduna (Scope includes access road, pavement, drainage, administrative building, warehouse, security post, MCC building, driver's lounge, general toilet, generator house, bundwall e.t.c)	EPC	Completed (2023)
NDPR	Contract for the construction of a trailer park for Ogebe refinery expansion project	C	Completed (2023)
AYM SHAFa	Contract for tank jacking and construction of a new tank foundation for tank 2,3 & 4 at AYM SHAFa LTD old terminal	EPC	Completed (2023)
AWKA MILLENIUM CITY – AWKA CAPITAL CITY, ANAMBRA	Excavation, sand bedding, laying of pipes & backfilling, installation of fire hydrants and water treatment system.	EPC	Completed 2022
STOCKGAP FUELS, PH Phase II	Construction of additional 1No x 4,000MT LPG Sphere at Port Harcourt	C	Completed 2022

CLIENT / LOCATION	PROJECT DESCRIPTION	SCOPE	YEAR
LIQUID BULK, P/H	Construction of 1No. X 4,000MT, 100% Propane Tank	C	Ongoing (2022)
NDPR, OGBELE	Construction of Trailer Park (Pavement & Accomodation) for the Ogbele Refinery	EPC	Ongoing (2021-2022)
A.Y.M. SHAFI, WARRI	Construction of Petroleum Depot Facilities (Construction of 2 x 5000m ³ , Tank Foundation) + Erection and Welding of 2 x 5,000m ³ LPG Spherical Tanks at Obitugbo, Warri North LG, Delta State	EPC	Completed 2021
RAIN OIL / PROMENADE OIL & GAS	EPC of Complete LPG Terminal with total capacity of 2 Nos. X 4,100MT (8,280 m ³) each sphere, +4bays weigh bridge loading Gantry	EPC	Completed 2020
TECHNO OIL, KIRIKIRI, APAPA	EPC of Complete LPG Terminal with total storage capacity of 2 Nos x 4,100MT (8,200M ³) Sphere each +2 bays weigh bridge loading gantry, including Berthing facility of 15,000 MT Vessel.	EPC	Completed 2020
TECHNOOIL, LAGOS	EPC of Complete LPG Terminal with total storage capacity of 2 Nos x 8,280 m ³ Each including Berthing facility of 15,000MT Vessel. Completed Oct. 2020 (Scope includes pavement, drainage, access road, administrative building, control room, security post, generator house etc.)	EPC	Completed 2020
NORTHWEST PETROLEUM, MEGA STATION GBAGADA - LAGOS III	Major facilities include a 24nos nozzles PMS, 4nos nozzles AGO, 2nos nozzles DPK, administrative building, drivers lounge, water treatment plant, dedicated transformer , tanker's park. etc	PC	Completed 2020
NORTHWEST PETROLEUM, MEGA STATION, ABULE EGBA -LAGOS IV	Major facilities include a 8nos PMS nozzles, 2nos AGO nozzles, 2nos DPK nozzles, a 9X25.3m, station building etc.	PC	Completed 2020
NORTHWEST PETROLEUM, MEGA FILLING STATION, ASABA II	Major facilities include a 20nos nozzles PMS, 4nos nozzles AGO, 2nos nozzles DPK, a 15X30m station building, drivers lounge, water treatment plant, dedicated transformer , tanker's park, etc.	PC	Completed 2019
KINGS CROWN / DOZZY OIL & GAS, CALABAR	Construction of 1No X 10,000M ³ (5,000MT) LPG Facility with associated pipeline in Calabar.	C	Completed 2019
DANGOTE / SAIPEM / PARESA, IBEJU- LEKKI, LAGOS	Construction of 1 No x 31,982m ³ Amonnia Tank (Dia 38m x Ht 28.2m) for Fertilizer Plant.	C	Completed 2019
NDPR, OGBELE	Flare Pipe Rack Foundation, Pipe Rack Installation & Piping Works	PC	Completed 2019
P.E. BITUMEN RESOURCES (PUMA), APAPA LAGOS	Complete EPC Upgrade of Bitumen Tank Farm. Scope include Firefighting, Electrical and Instrumentation works, renovation of existing administrative building.	EPC	Completed 2018
NDPR, OGBELE	Construction of 11 Nos. Product Tanks (5,000 – 10,000 bbl) including foundation works + equipment foundation and pipe racks	PC	Completed 2018
NDPR, OGBELE	Catalytic Reforming Unit Foundation Works	PC	Completed 2018
FYNEFIELD, CALABAR	Expansion of Tank Farm by construction of 1 No. x 8.4 Million Litres DPK Tank with Accessories and Piping Connections.	C	Completed 2018
PE BITUMEN RESOURCES, APAPA, LAGOS	Upgrade of Bitumen Tank Farm 18,000MT and 7,000MT respectively	EPC	Completed 2018
MENJ OIL, LAGOS	Tank farm Construction of 75 Ml total capacity (6 Nos Tanks) at Ijegun Egba Satelite town, Lagos	C	Completed 2017
NORTHWEST MEGA STATION, AJAH - LAGOS I	Major facilities include a 14nos PMS nozzles, 4nos AGO nozzles, 2nos DPK nozzles, a 9X15m station building, water treatment plant, dedicated transformer etc.	PC	Completed 2017
LEKOIL, OKTAKIKPO	Frac Tank Foundation Construction, Erection of Crude Oil Tank (3 No x 25,000bb), Fighting System and Associated Piping (Product & Fire Lines and Inter-connecting Piping at Otakikpo, River State	PC	Completed 2016

CLIENT / LOCATION	PROJECT DESCRIPTION	SCOPE	YEAR
ORYX, BENIN	Tank Farm Upgrade at Cotonou, Benin Republic.	C	Completed 2016
KADUNA REFINERY, KADUNA	Unloading and Reducing of Molesive + Repair and Calibration of PSVs.	M	Completed 2016
NAV GAS, LAGOS	LPG Tank Cleaning Services using Specialized Breathing Apparatus	M	Completed 2016
EXXON MOBIL - BRT	Installation of 3Nos. Marine Loading Arms from Technip FMC, France	I	Completed 2016
WOSBAB, LAGOS	Supply & Installation of Metering Equipment	PI	Completed 2016
SPG, CALABAR	Tank Farm Upgrade at Calabar	EPC	Completed 2016
NLNG, BONNY	Removal, Overhaul / Repairs and Reinstallation NLNG Condensate of FMC Marine Loading Arms of Jetty II Revamp Project.	M	Completed 2016
WABECO, CALABAR	Construction of 50ML White Product Storage capacity Terminal. & Construction of 7,000MT Bitumen Product storage tank including cut back tanks, 2bay loading gantry, 1.5km cargo line and heating system	EPC	Completed 2015
SPECIALITY OIL & GAS, CALABAR	Construction of LPG Piping (Cargoline from Jetty to Terminal and all process piping + Hydrant Piping for the Fire Fighting Systems).	C	Completed 2015
KTL, CALABAR	47.7ML Tank Farm Construction at Calabar	EPC	Completed 2015
LEKOIL, OKTAKIKPO	Erection of Crude Oil Tank (1 No x 25,000bb), Water Tank/Fire Fighting System and Associated Piping (Product & Fire Lines). Installation of Frac Tanks (40 Nos.) and Inter-connecting Piping	EPC	Completed 2015
FYNEFIELD,	Cargo Pipeline Construction & Supply of Metering System.	PIC	Completed 2015
NORTHWEST MEGA STATION, LEKKI - LAGOS II	Major facilities include a 20nos nozzles PMS, 4nos nozzles AGO, 2nos nozzles DPK, a driver's lounge, water treatment plant, dedicated transformer, tanker's park. etc	PC	Completed 2015
WABECO, CALABAR	EPC Contract for the Construction of 110,000MT Storage Tank Farm complete with Truck Loading Facility & Bitumen Blending Plant. (Scope includes pavement, bundwall, administrative building, workshop, control room, security post etc.)	EPC	Completed 2015
KTL, CALABAR	EPC Contract for Complete Tank Farm Construction (Scope includes access road, pavement, drainage, administrative building, gate house etc.)	EPC	Completed 2015
PILLAR OIL, DELTA STATE	EPC Contract for the Construction of 2 X 20,000BBL Crude Tank at Kwale (Scope include bundwall and pavement)	EPC	Completed 2014
ROM OIL, IBADAN	Construction and Erection of 15nos crude and refine palm oil storage tanks with associated piping system at Ibadan	PC	Completed 2014
WARTSILA, CALABAR	Civil works and Equipment Installation for Mfamosing 2, of 18MW power stations at Calabar	IC	Completed 2014
PILLAR OIL	EPC o 2nos X 20,000 bbls crude oil tanks at kwale complete with piping and fire fighting system	EPC	Completed 2014
OPTIMA ENERGY	Construction of PMS Tanks at Koko, Delta State.	EPC	Completed 2014
CYBERNETICS (Phase2)	Construction of PMS and ATK Tanks, Oghara.	EPC	Completed 2013
CYBERNETICS	Tank farm Upgrade - Expansion of existing tank, tank foundations and erection at Oghara	EPC	Completed 2013
ROM, OIL	Pipe Construction, Ibadan	C	Completed 2013
SAPETRO, BENIN	Crude Oil Tank Refurbishment, 2 Nos. X 50,000 MT Including Civil Work and Bund Wall Rehabilitation	EPC	Completed 2013
PIP I & II, CALABAR	EPC Contract of 1.5Km Access Road, Pavement, Drainage, Walkways etc.	EPC	Completed 2013

CLIENT / LOCATION	PROJECT DESCRIPTION	SCOPE	YEAR
CHEVRON, LAGOS	EGP Compressor		Completed 2014-2015
SAMON PETROLEUM CALABAR,	Construction of 60,000MT Petroleum Product Storage Depot at Calabar Free Trade Zone (Scope includes Pavement, bundwall administrative building, gate house etc.)	PC	Completed 2013
EMADEB, LAGOS	EPC Contract for the Construction of 5Nos. Product Tanks, 1No. Water Tank and Loading Gantry (Scope includes pavement around the bund area)	EPC	Completed 2013
ADDAX, IMO	Call-Off Contract Order of 25,000BBL Condensate Tank at Izombe, Imo State	EPC	Completed 2012
BPS, BENIN REPUBLIC	Construction of 40ML White product Storage Tank Farm, Complete with 6Bay Loading Facility (Scope includes pavement, access road, drainage, administrative building, gate house etc.)	EPC	Completed 2012
ST. LEO CATHOLIC CHURCH, LAGOS.	Construction of a 3Storey Civic Centre	EPC	Completed
NDPR, OGBELE	Construction of 133 X 63 Sqm. Trailer Park (Pavement & Accommodation) for the Ogbele Refinery.	EPC	Completed
NPDC, BENIN	PSV Certification and Calibration, Meter Proving, and servicing, FMC Procurement, Benin.	M	2006-2014
DADDO GAS, CALABAR	Construction of LPG Bottling Plant in Calabar	EPC	2013
T-TIME, LAGOS	Expansion of Depot and Installation of 1no 9.5ML PMS Tank, Ibafo	EPC	Completed 2013
NLNG, BONNY	5-Year Call-Off Contract for Molsieve Changeout – Completed in 2019	M	Completed 2008 - 2013
EXXONMOBIL	Portable Water for EAP Platform	PC	2013
EMADEB, LAGOS	EPC of 2Nos product tanks + 1No Fire water tank + loading gantry & associated piping & FMC TAS involving Enraf tank gauging system at Ijegun Egba, Lagos	EPC	Completed 2013
LIQUID BULK, P/H	Construction of 4 Nos. Product Tank + 1 No. Fire Water Storage Tank	C	Completed 2013
WABECO, CALABAR	Access Road and Infrastructure Construction at Calabar Portside Industrial Park	EPC	Completed 2012
AIL / ECOMARINE	Construction of Temporary Cargo Pipelines from NPA Jetty to PIP	EPC	Completed 2012
PHRC, Port Harcourt	Catalyst Supply from BASF, UK	P	Completed 2014
CHEVRON, LAGOS	Escravos Gas Plant – Molsieve Change out	M	Completed 2014
EXXONMOBIL	MOLSIEVE Supply for EAP Platform	P	Completed 2014
ADDAX, IZOMBE	Construction of additional 25,000bbl crude storage tank with associated works	C	Completed 2013
DOZZY OIL & GAS, CALABAR	Fire Fighting Facility at Calabar Jetty	PIC	Completed 2013
NAOC	Supply / Installation of 3 Nos. Prover Loop at Kwale / Ebocha / CC	PI	Completed 2013
KRPC, KADUNA	Installation of UOP Adsorbent Chamber Control System (ACCS)	I	Completed 2013
SAHARA, Lagos	Engineering Services for Ibafo Storage Tanks Facilities	Ct	Completed 2011
JUHI 2	Engineering design of aviation tanks and hydrant system at Ikeja Airport	E	Completed 2011
Fed. Min. of Works, Abuja	Rehab. Of Ife-Ondo Road in Osun & Ondo states. Total of 60.4KM	PC	Completed 2003 - 2004
SIRAGA/TISSOT/NAVIGAS	Construction of 2nos LPG Spheres of each 8181m ³ Capacity	PIC	Completed 2007
PHRC, Port Harcourt	Replacement of Burnt Pipelines at Okrika Jetty	EPC	Completed 1998
TSL/OANDO PLC	PHC Terminal Upgrade	EPC	Completed 2009
NAOC, PHC	OB/OB manifold extension	EPC	Completed 2009
BPS, Cotonou	40 ML Storage Tank Farm with 6 bay Loading Facility at Cotonou	EPIC	Completed 2010
CONOIL, PLC	Upgrade of petroleum product depot, E&C of 6New tanks with combined 50ML and associated piping, loading gantry, pumping system, firefighting system and warehouse.	EPIC	2009
St. LEO Catholic Church Ikeja	Construction of 3 Storey building Civic Centre	C	Completed 2009

CLIENT / LOCATION	PROJECT DESCRIPTION	SCOPE	YEAR
AITEO, Lagos	Lead Contractor for 85,000 MT Storage Tank Farm complete with 16 bay Loading Facility at Lagos Dockyard	EC	Completed 2008
NorthWestPet, Calabar	40 ML Storage Tank Farm complete with 8 bays Loading Facility at CFTZ	EPIC	Completed 2009
EXXONMOBIL	Engineering Service Agreement for 4 + 1 years for	ECt	2007-2008
FIRST DEEPWATER, Lagos	30 ML Storage Tank Farm complete with 6 bays Loading Facility at CFTZ	EPIC	Completed 2008
NorthWestPet, Lagos	32 ML Storage Tank Farm complete with 6 bay Loading Facility at Calabar Free Trade zone	EPIC	Completed 2007
NORTHWEST, CALABAR	Jetty Civil Construction & Fire Fighting System at CFTZ Calabar	EPC	Completed 2007
Platform Pet. Lagos	Eng. & Construction of 2nos x 10,000Bbbs Crude tank + 1no Fire Water Tank	EPC	Completed 2007
TOTAL, Lagos	Apapa, Pet. Product Tanks Construction – 3nos.	EPC	Completed 2008
AMEC Eng. Ltd. Lagos	Construction of 8 Hectares of Pavement for Oil Tanker Terminal at Iganmu-Orile, Lagos	PC	Completed 2007
NDDC, Port Harcourt	Ogba-Benin Water project	EPC	Completed 2006
TOTAL, Lagos	Abuja Aviation Depot Rehabilitation	EPC	2007
TOTAL/ELF, LAGOS	Basic Engineering for USAN Field Development/FPSO	Ct	Completed 2005
NAOC	EPC for the upgrade of Ogbainbiri flowstations for 13,000bbls/day to 35,000bbls/day complete with associated arrival manifold, metering system, flare-stack, pumps, piping system & staff accommodation	EPC	Completed 2004
KRPC, KADUNA	EPC of 10Cells x 1975M/Hr high efficiency FRP cooling towers, complete with chemical dosing facility and filtration system	EPC	Completed 2000

Legend -EPCIC

E -Engineering

P -Procurement

C -Construction

I -Installation

C -Commissioning

STATUTORY PERMITS

NMDPRA PERMIT



STATUTORY PERMITS

NMDPRA PERMIT



ISO CERTIFICATIONS



SOME JOB COMPLETION CERTIFICATE

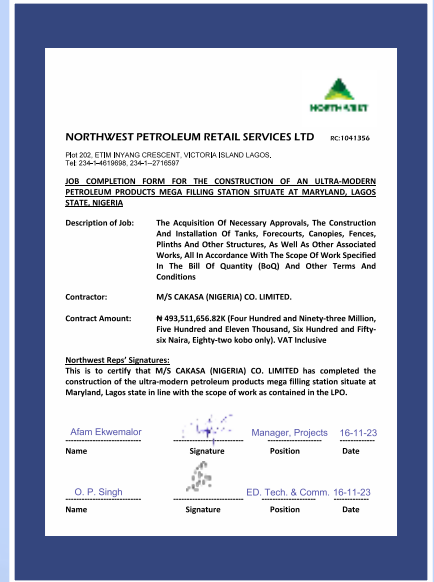

AWARDS & CERTIFICATIONS



AWARDS & CERTIFICATIONS



NIGERIAN CONTENT POLICY STATEMENT



NIGERIAN CONTENT POLICY STATEMENT

Cakasa (Nigeria) Company Limited has a statutory policy on Nigerian content Development committed to encouraging and maximizing Nigerian content in its operations which is fundamental to our goal of local capacity building and continued industrial growth.

The requirement of this policy is applied across board in all our operations based on the following values:

- Support the aspirations of the Nigerian government and our stakeholders to increase Nigerian content in the Nigerian oil and gas industry and ensure we comply with the NOGICD Act of 2010.
- Full implementation and utilization of the Nigerian Content Policy/Guidelines in order to ensure steady, measurable and sustainable growth of the Nigerian content.
- Promote the framework that guarantees active participation in the Oil and Gas sector as far as the Nigerian Content is concerned.
- Implement effective strategies to advance the continuous growth of Nigerian participation in all aspects of our operations.
- Deliver training to develop human capital and build sustainable Nigerian capabilities.
- Ensure the utilization of local raw materials, products and services.

Cakasa (Nigeria) Company Limited has embraced the above as the Company official Nigerian Content Policy arrangement.

Our aim is to:

- Ensure that Cakasa (Nigeria) Company Limited add value to Nigeria in order to stimulate the continuous growth of indigenization
- Ensure steady, measurable and sustainable growth of the Nigerian Content.

This is evident from our employment status both to our key personnel as well as the use of manpower in community areas where our projects are executed and our overall Nigerian Content quantum value applied and achieved in all aspects of our business.

Mr. Barnabas O. Olise
Managing Director / Chief Executive Officer

January 20, 2023



HEALTH SAFETY, ENVIRONMENT AND SECURITY POLICY

It is the policy of our company to carry out our activities in such a way that the life of all our employees and other people who may be connected with our operations are safeguarded. Emphasis must be placed on ensuring human health, operational safety, environmental protection, Security, quality enhancement, and community goodwill. This commitment is in the best interests of our customers, our employees and contractors, our stockholders, and the communities in which we live and work.

Cakasa requires the active commitment to, and accountability for, HSES from all employees and contractors. Line management has a leadership role in the communication and implementation of, and ensuring compliance with, HSES policies and standards. We are committed to

- Protect, and strive for improvement of, the health, safety and security of our people at all times;
- Eliminate Quality non-conformances and HSE accidents;
- Meet specified customer requirements and ensure continuous customer satisfaction;
- Set Quality & HSE performance objectives, measure results, assess and continually improve processes, services and product quality, through the use of an effective management system;
- Plan for, respond to and recover from any emergency, crisis and business disruption;
- Minimize our impact on the environment through pollution prevention, reduction of natural resource consumption and emissions, and the reduction and recycling of waste;
- Apply our technical skills to all HSE aspects in the design and engineering of our services and products;
- Communicate openly with stakeholders and ensure an understanding of our HSES policies, standards, programs and performance. Reward outstanding HSES performance;
- Improve our performance on issues relevant to our stakeholders that are of global concern and on which we can have an impact, and share with them our knowledge of successful HSES programs and initiatives.

This Policy shall be regularly reviewed to ensure ongoing suitability. The commitments listed are in addition to our basic obligation to comply with Cakasa Standard as well as all applicable laws and regulations where we operate. This is critical to our business success because it allows us to systematically minimize all losses and adds value for all our stakeholders.

A handwritten signature in green ink, appearing to read 'B. Olise', written over a light blue circular stamp.

Mr. Barnabas O. Olise
Managing Director/Chief Executive Officer
January 09, 2023



CAKASA QUALITY POLICY

We shall continuously deliver Engineering, Procurement, Construction and Post-installation services to the Oil & Gas, Industrial, Energy and Infrastructure clients, that meets our stakeholders needs and expectations as a demonstration of our total commitment to our customers and continual improvement of our Quality Management System.

This policy is established to support and drive the organization towards achieving its strategic plans and directions. To accomplish this, we shall:

1. Ensure that our Quality Policy is reviewed regularly to ensure it is appropriate to the purpose of our operation, continuously suitable and understood throughout our operation.
2. Promptly and consciously provide our external and internal clients with the precise information or services requested.
3. Commit all team players to meeting Client's Requirements and continually improve the effectiveness of our Quality Management System.
4. Establish our quality as framework for setting measureable goals & objectives that help drive productivity and system efficiency.
5. Create and preserve a work environment for all employees that fosters:
 - > Commitment to Quality & Teamwork
 - > Continuous process improvement
 - > Compliance with Health, Safety and Environmental Protection regulations.
6. Maintain our systems and work processes in accordance with the internationally recognized Quality management standard.
7. Establish the organization Strategies for both short terms and long terms to support the organization business continuity plan.
8. Measure the efficiency of our processes and ability to meet external and internal clients' legitimate requirements and expectations.
9. Avoid being placed in a position of conflict of interest and accept only work which can be handled competently and professionally.

SIGNED:

BARNABAS O. OLISE
MANAGING DIRECTOR/CHIEF EXECUTIVE OFFICER

DATE: 13 FEBRUARY 2023

STRATEGIC PARTNERS

Strategic Alliance Partner



Product Range/Service Type

Measurement solutions (Liquid, Gas & Integrated systems), Marine Loading systems

Supply and Maintenance of LPG Bottling Plant Equipment

LPG Truck Loading Arms and Folding Staircase

LPG spherical tanks & pressure vessels fabrication

Clean Energy Company

Catalyst handling equipments and shutdown Maintenance services.

Engineering, Consultancy and Project Management

Complete Engineering Services and Project Management

Maintenance & after sales service

Fire fighting systems design, manufacturing & installations.

Manufacturers of fuel, CNG & LPG Dispensers and other solution to retail commercial fuelling customer

LPG Reticulation and Integrated Billing System

LPG, CNG & LNG Consultant

Piling, Jetty Works And Special Foundations

Pipeline swampy equipments

CLIENTELE OIL/GAS & INFRASTRUCTURE



CLIENTELE OIL/GAS & INFRASTRUCTURE



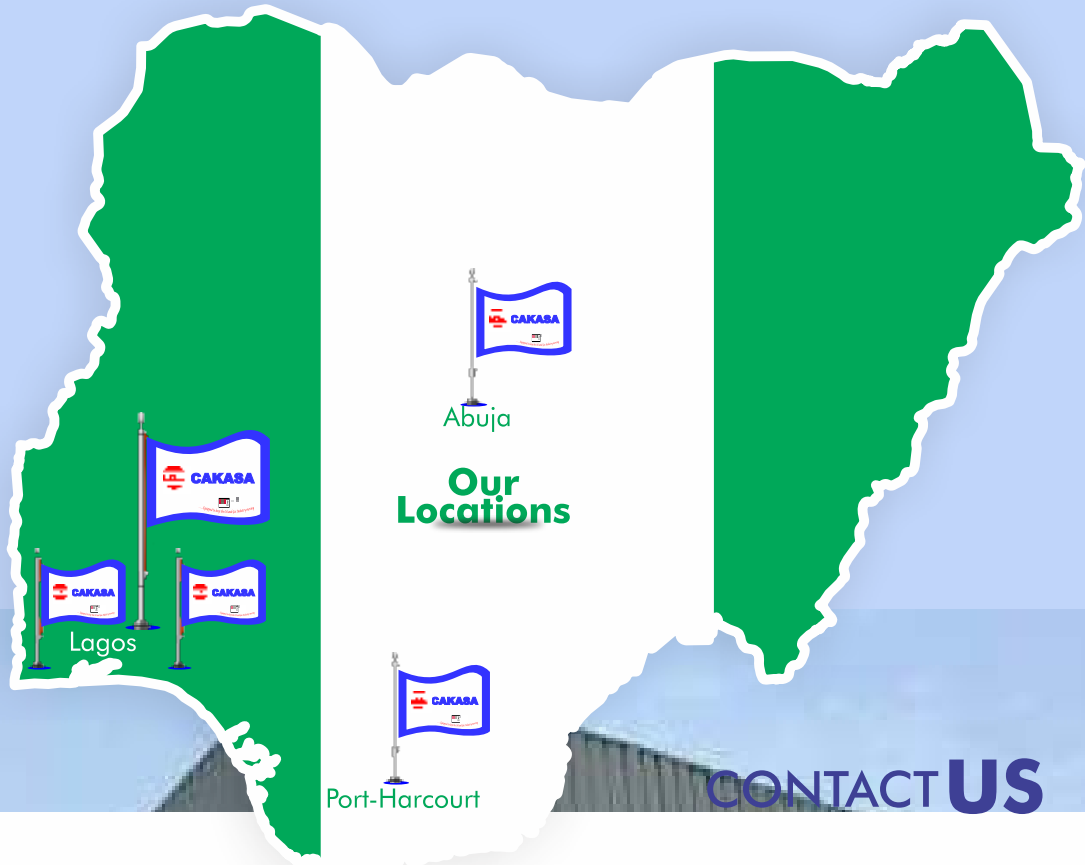

Our Locations

CONTACT US

CAKASA NIGERIA OFFICE

HEAD OFFICE

96, Palm Avenue
P. O. Box 871, Mushin, Lagos
Tel.: +234 815 929 0250

CONSTRUCTION OFFICE

6/8, Michael Adekoya Str.
Ilupeju, Lagos

PORT HARCOURT OFFICE

Plots 14, Emekuku Street
Oromineke Layout D/line
P.o. Box 2656 Port Harcourt

FABRICATION YARD

Plot 2, NERDC Road,
off Alhaja Ashabi Cole Str.,
Agidingbi, Ikeja, Lagos.

WAREHOUSE

55/57 Ajakaiye Street,
Onipetesi, Lagos

SUBSIDIARIES

ASSOCIATES

CSR

MEMBERSHIP

CESL
2nd Floor, The Rock Tower
Off C&I Leasing Street, Off
Bisola Durosimi Etti Street
Lekki Phase 1, Lagos.
www.cakasaengineering.com

IG
VIBROFLotation & GEOTECHNICAL CONSULTANTS
6/8, Michael Adekoya Str.
Ilupeju, Lagos
www.vibroflotation-ng.com

CAKASA ENGINEER FOUNDATION
6/8, Michael Adekoya Str.
Ilupeju, Lagos
www.cakasaebenezer.org

Technivac
CORROSION PREVENTION SPECIALISTS
Unit 6, Horsefair Road, Bridgend
CF31 3YN, UK
www.technivac.co.uk

CMSL **CAKASA MAINTENANCE SERVICES LTD**
Plots 14, Emekuku Street
Oromineke Layout D/line
P.o. Box 2656 Port Harcourt
www.cakasamaintenance.com

- NCDMB
- PETAN
- NSE
- MAN
- LCCI
- TRACE
- BVQI
- MRAN
- COREN
- ISPON
- NECA



...thus far the LORD has helped us



 info@cakasa.com/gas@cakasa.com

 +234 815 929 0250, +234 802 501 1792
+234 803 407 0350, +234 805 565 9813

 [cakasa \(Nig\) Company Limited](https://www.linkedin.com/company/cakasa)

 [cakasagas](https://www.instagram.com/cakasagas)

 www.cakasa.com

 **HEAD OFFICE**

96, Palm Avenue
P. O. Box 871, Mushin, Lagos
Tel.: +234 815 929 0250

CONSTRUCTION OFFICE

6/8, Michael Adekoya Str.
Ilupeju, Lagos
Tel.: +234 703 151 1125

